

Wilo-Atmos PICO



en Installation and operating instructions

Fig. 1:

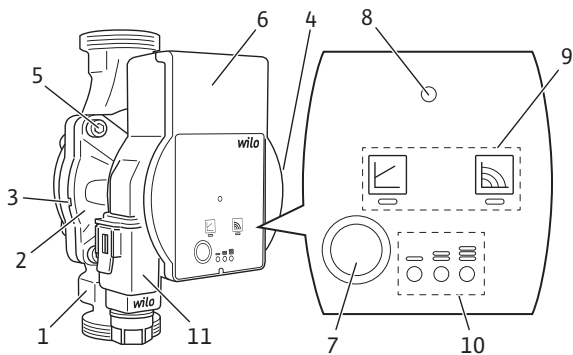

Fig. 2:

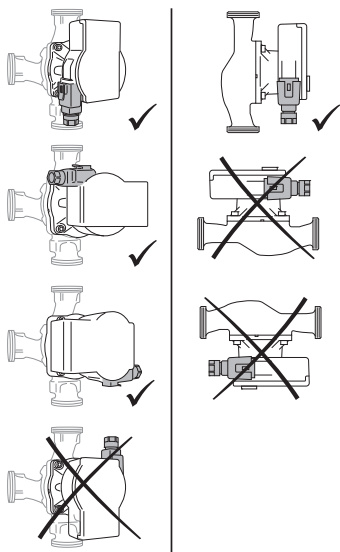

Fig. 3a:

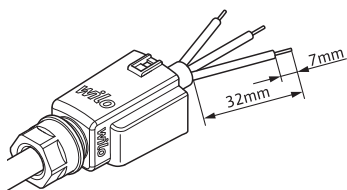

Fig. 3b:

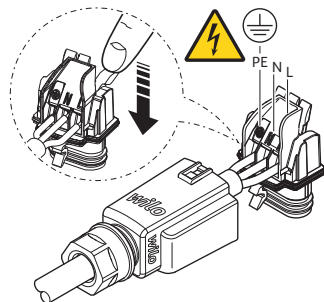

Fig. 3c:

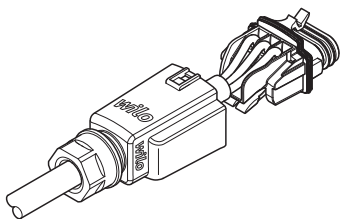

Fig. 3f:

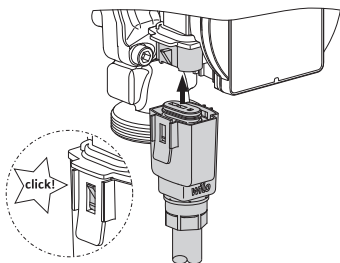

Fig. 3d:

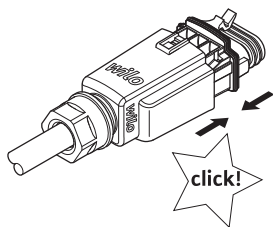

Fig. 4:

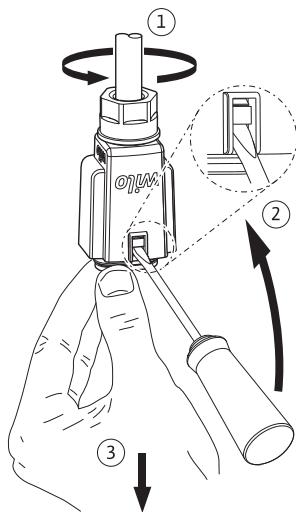
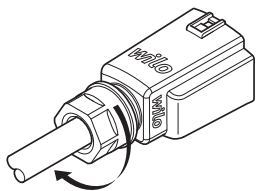

Fig. 3e:



1 General information

About these instructions

These installation and operating instructions are an integral part of the product. Read these instructions before commencing work and keep them in an accessible place at all times.

Strict adherence to these instructions is a precondition for the intended use and correct operation of the product. All information and markings on the product must be observed.

The language of the original operating instructions is German. All other languages of these instructions are translations of the original operating instructions.

2 Safety

This chapter contains basic information which must be adhered to during installation, operation and maintenance. Additionally, the instructions and safety instructions in the other chapters must be observed.

Failure to follow the installation and operating instructions will result in risk of injury to persons and damage to the environment and the product. This will result in the loss of any claims for damages.

Failure to follow the instructions will, for example, result in the following risks:

- Danger to persons due to electrical, mechanical and bacteriological factors as well as electromagnetic fields
- Environmental risks due to leakage of hazardous substances
- Property damage
- Failure of important functions of the product

Identification of safety instructions

These installation and operating instructions set out safety instructions for preventing personal injury and damage to property that are displayed in different ways:

- Safety instructions relating to personal injury start with a signal word and are **preceded by a corresponding symbol**.

- Safety instructions relating to property damage start with a signal word and are displayed **without** a symbol.

Signal words **DANGER!**

Failure to observe the safety instructions will result in serious injuries or death!

WARNING!

Failure to follow the instructions can lead to (serious) injuries!

CAUTION!

Failure to follow the instructions can lead to property damage and a possible total loss.

NOTE

Useful information on handling the product.

Symbols These instructions use the following symbols:



Danger due to electrical voltage



General danger symbol



Warning of hot surfaces/media



Warning of magnetic fields



Notes

Personnel qualifications Personnel must:

- Be instructed in the locally applicable accident prevention regulations.
- Have read and understood the installation and operating instructions.

Personnel must have the following qualifications:

- Electrical work must be carried out by an authorised electrician (in accordance with EN 50110-1).

- Installation/dismantling must be carried out by a qualified technician who is trained in the use of the necessary tools and mounting materials.
- The product must be operated by persons who are instructed in the functioning of the complete system.

Definition of “qualified electrician”

A qualified electrician is a person with appropriate technical education, knowledge and experience who can identify and prevent electrical hazards.

Electrical work

- Electrical work must be performed by a qualified electrician.
- Nationally applicable guidelines, standards and regulations as well as specifications by local energy supply companies for connection to the local power supply system must be observed.
- Before commencing work, disconnect the product from the mains and secure it against being switched on again.
- The connection must be protected by means of a residual-current device (RCD).
- The product must be earthed.
- Have defective cables replaced immediately by a qualified electrician.
- Never open the control module and never remove control elements.

Obligations of the operator

- Have all work carried out by qualified personnel only.
 - Ensure on-site contact protection from hot components and electrical hazards.
 - Have defective gaskets and connecting cables replaced.
- This device can be used by children from 8 years old as well as persons with limited physical, sensory or mental capabilities or lack of experience and knowledge, if they are supervised or instructed in the safe use of the device and they understand the dangers that may arise. Children are not allowed to play with the device. Cleaning and user maintenance may not be carried out by children without supervision.

3 Product description and function

- Overview** Wilo-Atmos PICO (Fig. 1)
- 1 Pump housing with screwed connections
 - 2 Glandless pump motor
 - 3 Condensate drain openings
(4x around circumference)
 - 4 Rating plate
 - 5 Housing screws
 - 6 Control module
 - 7 Operating push button
 - 8 Run signal/fault signal LED
 - 9 Display of selected control mode
 - 10 Display of selected characteristic curve (I, II, III)
 - 11 Wilo-Connector, electrical mains connection

Function High-efficiency circulator for hot-water heating systems with integrated differential pressure control. Control mode and delivery head (differential pressure) are adjustable. The differential pressure is controlled via the pump speed.

Type key

Example: Wilo-Atmos PICO 25/1-6-130

Atmos PICO	High-efficiency circulator
25	Screwed connection DN 25 (Rp 1)
1-6	1 = Minimum delivery head in m (adjustable down to 0.5 m) 6 = Maximum delivery head in m at $Q = 0 \text{ m}^3/\text{h}$
130	Port-to-port length: 130 mm or 180 mm

Technical data

Connection voltage	1 ~ 230 V \pm 10 %, 50/60 Hz
Protection class IP	See rating plate (4)
Energy efficiency index EEI	See rating plate (4)
Fluid temperatures at max. ambient temperature +40 °C	-10 °C to +95 °C
Fluid temperatures at max. ambient temperature +25 °C	-10 °C to +110 °C
Permitted ambient temperature	-10 °C to +40 °C
Max. operating pressure	10 bar (1000 kPa)
Min. inlet pressure at +95 °C/+110 °C	0.3 bar/1.0 bar (30 kPa/100 kPa)

Indicator lights (LEDs)

- Signal display
 - LED is lit up in green in normal operation
 - LED lights up/flashes in case of a fault (see chapter 10.1)



- Display of selected control mode Δp -v and constant speed



- Display of selected pump curve (I, II, III) within the control mode

Operating button



Press

- Select control mode
- Select pump curve (I, II, III) within the control mode



3.1 Control modes and functions

Variable differential pressure $\Delta p-v$ (I, II, III)

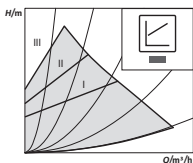

Recommended for two-pipe heating systems with radiators to reduce the flow noise at thermostatic valves.

The pump reduces the delivery head to half in the case of decreasing volume flow in the pipe network.

Electrical energy saving by adjusting the delivery head to the volume flow requirement and lower flow rates.

There are three pre-defined pump curves (I, II, III) to choose from.



NOTE

Factory setting: $\Delta p-v$, pump curve II

Constant speed (I, II, III)

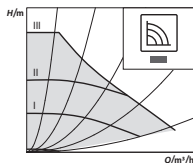

Recommended for systems with fixed system resistance requiring a constant volume flow.

The pump runs in three prescribed fixed speed stages (I, II, III).

4 Intended use

The high-efficiency circulators in the Wilo-Atmos PICO series are exclusively designed for circulating fluids in hot-water heating systems and similar systems with constantly changing volume flows.

Permitted fluids:

- Heating water according to VDI 2035 (CH: SWKI BT 102-01).
- Water-glycol mixtures* with a maximum of 50 % glycol.

* Glycol has a higher viscosity than water. If glycol is added, the delivery data of the pump must be corrected to suit the mixing ratio.

**NOTE**

Only add ready-to-use mixtures to the system. Do not use the pump to mix the fluid in the system.

Intended use includes observing these instructions and the data and markings on the pump.

Misuse Any use beyond the intended use is considered misuse and will result in the loss of all liability claims.

**WARNING!**

Danger of injury or material damage due to improper use!

- Never use non-specified fluids.
- Never allow unauthorised persons to perform work.
- Never operate the pump outside of the specified limits of use.
- Never carry out unauthorised conversions.
- Use authorised accessories only.
- Never operate with phase angle control.

5 Transportation and storage

Scope of delivery

- High-efficiency circulator with 2 gaskets
- Wilo-Connector
- Installation and operating instructions

Transport inspection Inspect for transportation damage and check completeness immediately after delivery, and claim immediately if necessary.

Transport and storage conditions Protect from moisture, frost and mechanical loads. Permissible temperature range: -10 °C to +50 °C.

6 Installation and electrical connection

6.1 Installation

May only be installed by qualified technicians.



WARNING!

Risk of burns due to hot surfaces!

Pump housing (1) and glandless pump motor (2) may become hot and result in burns on contact.

- During operation, touch the control module (6) only.
- Allow the pump to cool down before commencing any work.



WARNING!

Risk of burns due to hot fluids!

Hot fluids can result in scalding. Before installing or removing the pump, or undoing the housing screws (5), note the following:

- Allow the heating system to cool down completely.
- Close shut-off devices or drain the heating system.

Preparation

- Choose an installation point that is as easily accessible as possible.
- Observe the pump's allowable installation position (Fig. 2), rotate the motor head (2 + 6) if necessary.

CAUTION!

An incorrect installation position may damage the pump.

- Select the installation point in line with the allowable installation position (Fig. 2).
 - The motor must always be installed horizontally.
 - The electrical connection must never face upwards.
-

- Install shut-off devices upstream and downstream of the pump to facilitate pump replacement.

CAUTION!

Leaking water may damage the control module.

- Align the upper shut-off device such that leaking water cannot drip onto the control module (6).

- Align the upper shut-off device laterally.
- When installing in the feed of open systems, the safety supply must branch off upstream of the pump (EN 12828).
- Complete all welding and brazing tasks.
- Flush the pipe system.

Rotating the motor head

Rotate the motor head (2 + 6) before installing and connecting the pump.

- If necessary, remove the thermal insulation shell.



WARNING!

Risk of fatal injury from magnetic field!

Risk of death for people with medical implants due to permanent magnets installed in the pump.

- Never remove the rotor.

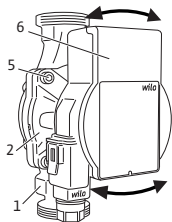

- Hold the motor head (2 + 6) and unscrew the 4 housing screws (5).

CAUTION!

Damage to the inner gasket leads to leakages.

- Carefully rotate the motor head (2 + 6) without removing it from the pump housing (1).
- Carefully rotate the motor head (2 + 6).
- Observe the allowable installation position (Fig. 2) and the direction arrow on the pump housing (1).
- Tighten (4–7.5 Nm) the 4 housing screws (5).

Installing the pump

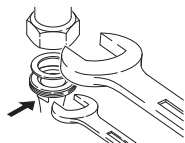
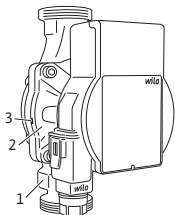

Observe the following points when installing the pump:

- Note the direction arrow on the pump housing (1).
- Install without tension, with glandless pump motor horizontal (2).
- Place gaskets in the screwed connections.
- Screw on threaded pipe unions.
- Secure the pump with an open-end wrench against twisting and screw tightly with the piping
- Re-mount the thermal insulation shell, if applicable.

CAUTION!

Insufficient heat dissipation and condensation water may damage the control module and the glandless pump motor.

- Do not thermally insulate the glandless pump motor (2).
- Ensure all condensate drain openings (3) are kept free.

6.2 Electrical connection

The electrical connection may only be performed by a qualified electrician.



DANGER!

Danger to life due to electrical voltage!

Immediate danger to life if live components are touched.

- Before commencing work, switch off the power supply and secure it against being switched on again.
- Never open the control module (6) and never remove control elements.

CAUTION!

Pulsed mains voltage can lead to damage to electronic components.

- Never operate the pump with phase angle control.
 - When switching the pump on or off using an external control unit, deactivate any voltage pulsing (e.g. phase angle control).
 - For applications where it is not clear whether the pump is operated with pulsed voltage, get the control/system manufacturer to confirm that the pump is operated with sinusoidal AC voltage.
 - Switching the pump on/off via triacs/solid-state relays must be examined on a case-by-case basis.
-

Preparation

- The current type and voltage must agree with the specifications on the rating plate (4).
- Maximum back-up fuse: 10 A, slow-blow.
- Only operate the pump with sinusoidal AC voltage.
- Note switching frequency:
 - On/off switching operations via mains voltage $\leq 100/24$ h.
 - $\leq 20/h$ for a switching frequency of 1 min. between switching on/off via mains voltage.
- The electrical connection must be made via a fixed connecting cable equipped with a connector device or an all-pole switch with a contact opening width of at least 3 mm (VDE 0700/Part 1).
- Use a connecting cable with a sufficient outer diameter (e.g. H05VV-F3G1.5) to protect against leaking water and to ensure strain relief at the threaded cable connection.
- Use a heat-resistant connecting cable where fluid temperatures exceed 90 °C.
- Ensure that the connecting cable does not make contact with either the pipes or the pump.

Fitting the Wilo-Connector

- Disconnect the connecting cable from the power supply.
- Observe the terminal allocations (PE, N, L).
- Connect and fit the Wilo-Connector (Fig. 3a to 3e).

Connecting the pump

- Earth the pump.
- Connect the Wilo-Connector (9) to the control module (6) until it snaps into place (Fig 3f).

Removing the Wilo-Connector

- Disconnect the connecting cable from the power supply.
- Remove the Wilo-Connector using a suitable screw-driver (Fig. 4).

7 Commissioning

Commissioning only by qualified technicians.

7.1 Venting

- Fill and vent the system correctly.
- ↳ The pump vents automatically when first started.

7.2 Setting the control mode





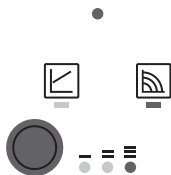

Select control mode

The LED selection of control modes and corresponding pump curves takes place in clockwise succession.

- Press the operating button briefly (approx. 1 second).
- ↳ LEDs display the set control mode and pump curve.

The following shows the various possible settings (for example: constant speed / characteristic curve III):



	LED display	Control mode	Pump curve
1		Constant speed	II
2		Constant speed	I
3		Variable differential pressure $\Delta p-v$	III
4		Variable differential pressure $\Delta p-v$	II
5		Variable differential pressure $\Delta p-v$	I
6		Constant speed	III

- Pressing the button for the 6th time returns to the basic setting (constant speed / characteristic curve III).



NOTE

All settings and displays are retained if the power supply is interrupted.

8 Decommissioning

- Shutting down the pump** Shut down the pump immediately in case of damage to the connecting cable or other electrical components.
- Disconnect the pump from the power supply.
 - Contact Wilo customer service or a specialist technician.

9 Maintenance

- Cleaning**
- Carefully remove soiling from the pump on a regular basis using a dry duster.
 - Never use liquids or aggressive cleaning agents.

10 Faults, causes and remedies

The troubleshooting must only be performed by a qualified specialist, work on the electrical connection must only be performed by a qualified electrician.

Faults	Causes	Remedies
Pump is not running although the power supply is switched on	Electrical fuse defective	Check fuses
	Pump has no voltage	Resolve the power interruption
Pump making noises	Cavitation due to insufficient suction pressure	Increase the system pressure within the permissible range
		Check the delivery head and set it to a lower head if necessary
Building does not get warm	Thermal output of the heating surfaces is too low	Increase setpoint

10.1 Fault signals

- The fault signal LED indicates a fault.
- The pump switches off (depending on the fault) and attempts a cyclical restart.

LED	Faults	Causes	Remedy
Lights up red	Blocking	Rotor blocked	Activate manual restart or contact customer service
	Contacting/ winding	Winding defective	
Flashes red	Under/overvoltage	Power supply too low/high on mains side	Check mains voltage and operating conditions, and request customer service
	Excessive module temperature	Module interior too warm	
	Short-circuit	Motor current too high	
Flashes red/ green	Generator operation	Water is flowing through the pump hydraulics, but there is no mains voltage at the pump	Check the mains voltage, water quantity/pressure and the ambient conditions
	Dry run	Air in the pump	
	Overload	Sluggish motor, pump is operated outside of its specifications (e.g. high module temperature). The speed is lower than during normal operation	

If the fault cannot be remedied, contact a specialist technician or Wilo customer service.

11 Disposal

Information on the collection of used electrical and electronic products

Proper disposal and appropriate recycling of this product prevents damage to the environment and dangers to your personal health.



NOTE

Disposal in domestic waste is forbidden!

In the European Union, this symbol can appear on the product, the packaging or the accompanying documentation. It means that the electrical and electronic products in question must not be disposed of along with domestic waste.

To ensure proper handling, recycling and disposal of the used products in question, please note the following points:

- Only hand over these products at designated, certified collecting points.
- Observe the locally applicable regulations!

Please consult your local municipality, the nearest waste disposal site, or the dealer who sold the product to you for information on proper disposal. For further information on recycling, go to www.wilo-recycling.com.



DECLARATION OF CONFORMITY

Atmos PICO...

We, the manufacturer, declare under our sole responsibility that these glandless circulating pump types of the series,

(The serial number is marked on the product site plate)

in their delivered state comply with the following relevant directives and with the relevant national legislation:

- _ **Electrical Equipment (Safety) Regulations (SI 2016 No. 1101) amended**
- _ **Electromagnetic Compatibility (EMC) Regulations (SI 2016 No. 1091) amended**
- _ **Eco-design for Energy-Related Products Regulations (SI 2010 No. 2617) as amended by Eco-design for Energy-Related Products and Energy Information (Amendment) (EU Exit) Regulations (SI 2019 No. 539)**
- _ **Restriction of the Use of Certain Hazardous Substances (RoHS) in Electrical and Electronic Equipment Regulations (SI 2012 No. 3032) amended**

comply also with the following relevant standards:

BS EN 60335-1:2012+A11:2014+A13:2017+A1:2019+A2:2019+A14:2019+A15:2021;
BS EN 60335-2-51:2003+A1:2008+A2:2012; BS EN IEC 61000-6-1:2019;
BS EN IEC 61000-6-2:2019; BS EN IEC 61000-6-3:2021; BS EN IEC 61000-6-4:2019;
BS EN 16297-1:2012; BS EN 16297-2:2012; BS EN IEC 63000:2018;

Person who places the product on the market:

Dortmund, 2023-04-28

DocuSigned by
i.V. Claudia Brasse
A0201CF4DECC3A46

H. HERCHENHEIN
Senior Vice President - Group Quality & Qualification

Declaration n°2215717-rev04

Wilo (UK) Ltd
2nd Avenue, Centrum 100
Burton upon Trent - DE14 2WJ
Staffordshire - United Kingdom

wilo

WiloPark 1
D-44263 Dortmund

PC As-Sh n°4216446-GB-rev11



DECLARATION OF CONFORMITY

Atmos PICO...

We, the manufacturer, declare under our sole responsibility that these glandless circulating pump types of the series,

(The serial number is marked on the product site plate)

in their delivered state comply with the following relevant directives and with the relevant national legislation:

_ ELECTRICAL EQUIPMENT SAFETY SCHEME (EES)

_ RADIOCOMMUNICATIONS LABELLING (ELECTROMAGNETIC COMPATIBILITY) NOTICE 2017

comply also with the following relevant standards:

AS/NZS 60335.1:2020; AS/NZS 60335.2.51:2020; AS/NZS 61000.6.1:2006 (R2016); AS/NZS 61000.6.2:2022; AS/NZS 61000.6.3:2021; AS 61000.6.4:2020;

Person authorized to compile the technical file is:

Wilco Australia Head Office
Unit 2, 29 Alexandra Place
Murarrie QLD 4172 Australia

Dortmund, 2023-04-28

DocuSigned by:
i.V. Claudia Brasse
A5291CF4DEC34A9

H. HERCHENHEIN
Senior Vice President - Group Quality & Qualification

wilo

Wilopark 1
D-44263 Dortmund



DECLARATION OF CONFORMITY KONFORMITÄTSERKLÄRUNG

We, the manufacturer, declare under our sole responsibility that these glandless circulating pump types of the series,
Als Hersteller erklären wir unter unserer alleinigen Verantwortung, dass die Nassläufer-Umwälzpumpen der Baureihen,

Atmos PICO ...

(The serial number is marked on the product site plate)
(Die Seriennummer ist auf dem Typenschild des Produktes angegeben)

in their delivered state comply with the following relevant directives and with the relevant national legislation:
in der gelieferten Ausführung folgenden einschlägigen Bestimmungen entsprechen 'und entsprechender nationaler Gesetzgebung:

_ 2014/35/EU - LOW VOLTAGE / NIEDERSpannungsRICHTLINIE

_ 2014/30/EU - ELECTROMAGNETIC COMPATIBILITY / ELEKTROMAGNETISCHE VERTRÄGLICHKEIT - RICHTLINIE

_ 2009/125/EC - ENERGY-RELATED PRODUCTS / NERGIEVERBRAUCHSRELEVANTER PRODUKTE - RICHTLINIE
(and according to the regulation 641/2009 on glandless circulators amended by 622/2012 / und gemäß der Verordnung (EG) Nr. 641/2009 über Nassläuferpumpen, geändert durch 622/2012)

_ 2011/65/EU + 2015/863 - RESTRICTION OF THE USE OF CERTAIN HAZARDOUS SUBSTANCES /
BESCHRÄNKUNG DER VERWENDUNG BESTIMMTER GEFÄHRLICHER STOFFE-RICHTLINIE

comply also with the following relevant standards:
sowie auch den Bestimmungen zu folgenden harmonisierten europäischen Normen:

EN 60335-1:2012+A11:2014+A13:2017+A1:2019+A2:2019+A14:2019+A15:2021;
EN 60335-2-51:2003+A1:2008+A2:2012; EN IEC 61000-6-1:2019; EN IEC 61000-6-2:2019;
EN IEC 61000-6-3:2021; EN IEC 61000-6-4:2019; EN 16297-1:2012; EN 16297-2:2012; EN IEC 63000:2018;

Person authorized to compile the technical file is:
Bevollmächtigter für die Zusammenstellung der technischen Unterlagen ist:

WILO SE
Group Quality
Wilopark 1
D-44263 Dortmund

Dortmund, 2023-04-28

DocuSigned by:
i.V. Claudia Brasse
A5291CFADEC34A8...

H. HERCHENHEIN
Senior Vice President - Group Quality & Qualification

wilo
Wilopark 1
D-44263 Dortmund

EL	<p>Εμείς, ο κατασκευαστής, δηλώνουμε με αποκλειστικά δική μας ευθύνη ότι οι υδρόλιπαντοι κυκλοφορητές της σειράς (Ο σειριακός αριθμός σημειώνεται στο ταμπλάκι του προϊόντος) στην κατάσταση παράδοσης συμμορφώνονται με τις ακόλουθες σχετικές οδηγίες και τη σχετική εθνική νομοθεσία:</p> <p> 2014/35/EU - Χαμηλής Τάσης 2014/30/EU - Ηλεκτρομαγνητικής συμβατότητας 2009/125/EC - Συνδεδεμένα με την ενέργεια προϊόντα 2011/65/EU + 2015/863 - για τον περιορισμό της χρήσης ορισμένων επικίνδυνων ουσιών</p> <p>συμμορφώνεται επίσης με εναρμονισμένα πρότυπα:</p> <p>EN 60335-1:2012+A11:2014+A13:2017+A1:2019+A2:2019+A14:2019+A15:2021; EN 60335-2-51:2003+A1:2008+A2:2012; EN IEC 61000-6-1:2019; EN IEC 61000-6-2:2019; EN IEC 61000-6-3:2012; EN IEC 61000-6-4:2019; EN 16297-1:2012; EN 16297-2:2012; EN IEC 63000:2018;</p> <p>Πρόσωπο εξουσιοδοτημένο να συντάξει το τεχνικό αρχείο είναι: D-44263 Dortmund</p>	<p>Atmos PICO ...</p> <p>WILO SE Group Quality Wilopark 1</p>
ES	<p>Nosotros, el fabricante, declaramos bajo nuestra exclusiva responsabilidad que los circuladores de rotor húmedo de la(s) serie(s) (El nº de serie está marcado en la placa de características del producto) cumple en la ejecución suministrada las siguientes disposiciones pertinentes y la legislación nacional correspondiente:</p> <p> 2014/35/EU - Baja Tensión 2014/30/EU - Compatibilidad Electromagnética 2009/125/EC - Productos relacionados con la energía 2011/65/EU + 2015/863 - Restricciones a la utilización de determinadas sustancias peligrosas</p> <p>así como las disposiciones de las siguientes normas europeas armonizadas:</p> <p>EN 60335-1:2012+A11:2014+A13:2017+A1:2019+A2:2019+A14:2019+A15:2021; EN 60335-2-51:2003+A1:2008+A2:2012; EN IEC 61000-6-1:2019; EN IEC 61000-6-2:2019; EN IEC 61000-6-3:2012; EN IEC 61000-6-4:2019; EN 16297-1:2012; EN 16297-2:2012; EN IEC 63000:2018;</p> <p>Persona autorizada para la recopilación de los documentos técnicos: D-44263 Dortmund</p>	<p>Atmos PICO ...</p> <p>WILO SE Group Quality Wilopark 1</p>
FR	<p>Nous, fabricant, déclarons sous notre seule responsabilité que les types de circulateurs des séries, (Le numéro de série est inscrit sur la plaque signalétique du produit) dans leur état de livraison sont conformes aux dispositions des directives suivantes et aux législations nationales les transposant :</p> <p> 2014/35/EU - BASSE TENSION 2014/30/EU - COMPATIBILITE ELECTROMAGNETIQUE 2009/125/EC - PRODUITS LIES A L'ENERGIE (et conformément au règlement 641/2009 sur les circulateurs à rotor noyé amendé par 622/2012) 2011/65/EU + 2015/863 - LIMITATION DE L'UTILISATION DE CERTAINES SUBSTANCES DANGEREUSES</p> <p>sont également conformes aux dispositions des normes européennes harmonisées suivantes :</p> <p>EN 60335-1:2012+A11:2014+A13:2017+A1:2019+A2:2019+A14:2019+A15:2021; EN 60335-2-51:2003+A1:2008+A2:2012; EN IEC 61000-6-1:2019; EN IEC 61000-6-2:2019; EN IEC 61000-6-3:2012; EN IEC 61000-6-4:2019; EN 16297-1:2012; EN 16297-2:2012; EN IEC 63000:2018;</p> <p>Personne autorisée à constituer le dossier technique est : D-44263 Dortmund</p>	<p>Atmos PICO ...</p> <p>WILO SE Group Quality Wilopark 1</p>
IT	<p>Noi, il costruttore, dichiariamo sotto la nostra esclusiva responsabilità che questi tipi di circolatori a rotore bagnato della serie, (Il numero di serie è riportato sulla targhetta del sito del prodotto) allo stato di consegna sono conformi alle seguenti direttive pertinenti e alla legislazione nazionale pertinente:</p> <p> 2014/35/EU - Bassa Tensione 2014/30/EU - Compatibilità Elettromagnetica 2009/125/EC - Prodotti connessi all'energia 2011/65/EU + 2015/863 - sulla restrizione dell'uso di determinate sostanze pericolose</p> <p>rispettare anche le seguenti norme pertinenti:</p> <p>EN 60335-1:2012+A11:2014+A13:2017+A1:2019+A2:2019+A14:2019+A15:2021; EN 60335-2-51:2003+A1:2008+A2:2012; EN IEC 61000-6-1:2019; EN IEC 61000-6-2:2019; EN IEC 61000-6-3:2012; EN IEC 61000-6-4:2019; EN 16297-1:2012; EN 16297-2:2012; EN IEC 63000:2018;</p> <p>La persona autorizzata a compilare il fascicolo tecnico è: D-44263 Dortmund</p>	<p>Atmos PICO ...</p> <p>WILO SE Group Quality Wilopark 1</p>
PT	<p>Nós, o fabricante, declaramos sob nossa exclusiva responsabilidade que o(s) circulador(es) de rotor húmido da(s) série(s), (O nº de série está marcado na placa de características do produto) está em conformidade com a versão fornecida nas seguintes disposições relevantes e de acordo com a legislação nacional</p> <p> 2014/35/EU - Baixa Voltagem 2014/30/EU - Compatibilidade Electromagnética 2009/125/EC - Produtos relacionados com o consumo de energia 2011/65/EU + 2015/863 - relativa à restrição do uso de determinadas substâncias perigosas</p> <p>assim como as seguintes disposições das normas europeias</p> <p>EN 60335-1:2012+A11:2014+A13:2017+A1:2019+A2:2019+A14:2019+A15:2021; EN 60335-2-51:2003+A1:2008+A2:2012; EN IEC 61000-6-1:2019; EN IEC 61000-6-2:2019; EN IEC 61000-6-3:2012; EN IEC 61000-6-4:2019; EN 16297-1:2012; EN 16297-2:2012; EN IEC 63000:2018;</p> <p>Pessoa autorizada para a elaboração de documentos técnicos: D-44263 Dortmund</p>	<p>Atmos PICO ...</p> <p>WILO SE Group Quality Wilopark 1</p>

DA Officiel oversættelse af erklæringen	<p>Vi, producenten, erklærer under vores eget ansvar, at disse kirtelfrie cirkulationspumpe typer i serien, (Serienummeret er markeret på produktpladen) i deres leverede tilstand overholde følgende relevante direktiver og den relevante nationale lovgivning:</p> <p>Atmos PICO ...</p> <p> 2014/35/EU - Lavspændings 2014/30/EU - Elektromagnetisk Kompatibilitet 2009/125/EC - Energi relaterede produkter 2011/65/EU + 2015/863 - Begrænsning af anvendelsen af visse farlige stoffer</p> <p>også overholde følgende relevante standarder:</p> <p>EN 60335-1:2012+A11:2014+A13:2017+A1:2019+A2:2019+A14:2019+A15:2021; EN 60335-2-51:2003+A1:2008+A2:2012; EN IEC 61000-6-1:2019; EN IEC 61000-6-2:2019; EN IEC 61000-6-3:2012; EN IEC 61000-6-4:2019; EN 16297-1:2012; EN 16297-2:2012; EN IEC 63000:2018;</p> <p>WILO SE Group Quality Wilopark 1</p> <p>Person, der er autoriseret til at udarbejde den tekniske fil, er: D-44263 Dortmund</p>
ET Deklaratsiooni ametlik tõlge	<p>Meie, tootja, kuulutame ainuiskilulise vastutusega, et need seeria näärmeteta tsirkulatsioonipumbad, (Seerianumber on märgitud toote saidi plaadile) oma tarnitud olekus järgima järgmisi asjakohaseid direktiive ja asjakohaseid siseriiklikke õigusakte:</p> <p>Atmos PICO ...</p> <p> 2014/35/EU - Madalpingeseadmed 2014/30/EU - Elektromagnetilisi Ühilduvust 2009/125/EC - Energiamaojuha toodete 2011/65/EU + 2015/863 - teatavate ohtlike ainete kasutamise piiramise kohta</p> <p>vastama ka järgmistele asjakohastele standarditele:</p> <p>EN 60335-1:2012+A11:2014+A13:2017+A1:2019+A2:2019+A14:2019+A15:2021; EN 60335-2-51:2003+A1:2008+A2:2012; EN IEC 61000-6-1:2019; EN IEC 61000-6-2:2019; EN IEC 61000-6-3:2012; EN IEC 61000-6-4:2019; EN 16297-1:2012; EN 16297-2:2012; EN IEC 63000:2018;</p> <p>WILO SE Group Quality Wilopark 1</p> <p>Tehnilise toimiku koostamiseks on volitatud isik: D-44263 Dortmund</p>
FI Julistuksen virallinen käännös	<p>Me valmistajana vakuutamme yksinomaisella vastuullamme, että nämä sarjan tiivisteettömät kiertovesipumput, (Sarjanumero on merkitty tuotekohtaaiseen kilpeen) toimitetussa tilassa noudattavat seuraavia asiaankuuluvia direktiivejä ja asiaa koskevaa kansallista lainsäädäntöä:</p> <p>Atmos PICO ...</p> <p> 2014/35/EU - Matala Jännite 2014/30/EU - Sähkömagneettinen Yhteensopivuus 2009/125/EC - Energiaan liittyvien tuotteiden 2011/65/EU + 2015/863 - tiettyjen vaarallisten aineiden käytön rajoittamisesta</p> <p>noudattamaan myös seuraavia asiaankuuluvia standardeja:</p> <p>EN 60335-1:2012+A11:2014+A13:2017+A1:2019+A2:2019+A14:2019+A15:2021; EN 60335-2-51:2003+A1:2008+A2:2012; EN IEC 61000-6-1:2019; EN IEC 61000-6-2:2019; EN IEC 61000-6-3:2012; EN IEC 61000-6-4:2019; EN 16297-1:2012; EN 16297-2:2012; EN IEC 63000:2018;</p> <p>WILO SE Group Quality Wilopark 1</p> <p>Henkilö, jolla on valtuudet koota tekninen tiedosto, on: D-44263 Dortmund</p>
IS Oþinber þýðing á yfirlýsingunni	<p>Við framleiðandinn lýsum því yfir undir ábyrgð okkar einungis að þessar kirtillausu hringlaga dælugerðir seríunnar, (Raðnúmerið er merkt á plötunni á vörustaðnum) í afhentu ástandi í samræmi við eftirfarandi viðeigandi tilskipanir og viðeigandi innlenda löggjöf:</p> <p>Atmos PICO ...</p> <p> 2014/35/EU - Lágspennutílskipun 2014/30/EU - Rafseguls-samhæfni-tilskipun 2009/125/EC - Tilskipun varðandi vörur tengdar orkunotkun 2011/65/EU + 2015/863 - Takmörkun á notkun tiltekinna hættulegra efna</p> <p>uppfylla einnig eftirfarandi viðeigandi staðla:</p> <p>EN 60335-1:2012+A11:2014+A13:2017+A1:2019+A2:2019+A14:2019+A15:2021; EN 60335-2-51:2003+A1:2008+A2:2012; EN IEC 61000-6-1:2019; EN IEC 61000-6-2:2019; EN IEC 61000-6-3:2012; EN IEC 61000-6-4:2019; EN 16297-1:2012; EN 16297-2:2012; EN IEC 63000:2018;</p> <p>WILO SE Group Quality Wilopark 1</p> <p>Sá sem hefur heimild til að taka saman teikniskrána er: D-44263 Dortmund</p>
LT Oficialus deklaracijos vertimas	<p>Mes, kaip gamintojas, savo atsakomybės ribose deklaruojame, kad šios serijos šlapio rotoriaus suvilo modeliai, (Serijos numeris pažymėtas ant produkto lentelės) taip kaip pristatyti, atitinka sekančias aktualias direktyvas ir nacionalines teisės normas bei reglamentus:</p> <p>Atmos PICO ...</p> <p> 2014/35/EU - Žema įtampa 2014/30/EU - Elektromagnetinis Suderinamumas 2009/125/EC - Energija susijusiems gaminiams 2011/65/EU + 2015/863 - dėl tam tikrų pavojingų medžiagų naudojimo apribojimo</p> <p>taip pat atitinka sekančius aktualius standartus:</p> <p>EN 60335-1:2012+A11:2014+A13:2017+A1:2019+A2:2019+A14:2019+A15:2021; EN 60335-2-51:2003+A1:2008+A2:2012; EN IEC 61000-6-1:2019; EN IEC 61000-6-2:2019; EN IEC 61000-6-3:2012; EN IEC 61000-6-4:2019; EN 16297-1:2012; EN 16297-2:2012; EN IEC 63000:2018;</p> <p>WILO SE Group Quality Wilopark 1</p> <p>Asmuo įgallotas sudaryti techninius dokumentus yra: D-44263 Dortmund</p>

LV	<p>Mēs, ražotājs, ar pilnu atbildību paziņojam, ka šie slapjā rotora cirkulācijas sūkņu tipi, (Sērijas numurs ir norādīts uz izstrādājuma plāksnītes)</p> <p>piegādātāja valstī atbilst šādām attiecīgām direktīvām un attiecīgiem valsts tiesību aktiem:</p> <p> 2014/35/EU - Zemsprieguma 2014/30/EU - Elektromagnētiskās Saderības 2009/125/EC - Enerģiju saistītiem ražojumiem 2011/65/EU + 2015/863 - par dažu bīstamu vielu izmantošanas ierobežošanu 2011/65/UE</p> <p>atbilst arī sekojošiem attiecīgiem standartiem:</p> <p>EN 60335-1:2012+A11:2014+A13:2017+A1:2019+A2:2019+A14:2019+A15:2021; EN 60335-2-51:2003+A1:2008+A2:2012; EN IEC 61000-6-1:2019; EN IEC 61000-6-2:2019; EN IEC 61000-6-3:2021; EN IEC 61000-6-4:2019; EN 16297-1:2012; EN 16297-2:2012; EN IEC 63000:2018;</p> <p style="text-align: right;">WILO SE Group Quality Wilopark 1</p> <p style="text-align: right;">Persona pilnvarota sastādīt tehnisko dokumentāciju: D-44263 Dortmund</p>
NL	<p>Wij, de fabrikant, verklaren onder onze eigen verantwoordelijkheid dat deze natloper-circulatiepompen van de serie, (Het serienummer staat vermeld op het naamplaatje van het product)</p> <p>in de geleverde versie voldoen aan de volgende relevante bepalingen en aan de overeenkomstige nationale wetgeving:</p> <p> 2014/35/EU - Laagspannings 2014/30/EU - Elektromagnetische Compatibiliteit 2009/125/EC - Energiegerelateerde producten 2011/65/EU + 2015/863 - betreffende beperking van het gebruik van bepaalde gevaarlijke stoffen</p> <p>voldoen ook aan de volgende relevante normen:</p> <p>EN 60335-1:2012+A11:2014+A13:2017+A1:2019+A2:2019+A14:2019+A15:2021; EN 60335-2-51:2003+A1:2008+A2:2012; EN IEC 61000-6-1:2019; EN IEC 61000-6-2:2019; EN IEC 61000-6-3:2021; EN IEC 61000-6-4:2019; EN 16297-1:2012; EN 16297-2:2012; EN IEC 63000:2018;</p> <p style="text-align: right;">WILO SE Group Quality Wilopark 1</p> <p style="text-align: right;">De persoon die bevoegd is om het technische bestand samen te stellen is: D-44263 Dortmund</p>
NO	<p>Vi som produsent erklærer herved vårt ansvar at våtløper sirkulasjonspumper under type serie, (serienummeret er markert på pumpeskilt)</p> <p>I levert tilstand vil produkt overholde følgende direktiver og relevant nasjonal lovgivning</p> <p> 2014/35/EU - Lavspenningsdirektiv 2014/30/EU - EMV-Elektromagnetisk kompatibilitet 2009/125/EC - Direktiv energirelaterete produkter 2011/65/EU + 2015/863 - Begrensning av bruk av visse farlige stoffer</p> <p>Oppfølger også relevante standarder</p> <p>EN 60335-1:2012+A11:2014+A13:2017+A1:2019+A2:2019+A14:2019+A15:2021; EN 60335-2-51:2003+A1:2008+A2:2012; EN IEC 61000-6-1:2019; EN IEC 61000-6-2:2019; EN IEC 61000-6-3:2021; EN IEC 61000-6-4:2019; EN 16297-1:2012; EN 16297-2:2012; EN IEC 63000:2018;</p> <p style="text-align: right;">WILO SE Group Quality Wilopark 1</p> <p style="text-align: right;">Vedkommendesom er autorisert til å sammenstille teknisk fil er: D-44263 Dortmund</p>
SV	<p>Vi, tillverkaren, försäkrar under eget ansvar att de våtlöpande cirkulationspumparna i serien (Serienumret finns utmärkt på produktens dataskyilt)</p> <p>i det utförande de levererades överrenstämmer med följande relevanta direktiv och relevant nationell lagstiftning</p> <p> 2014/35/EU - Lågspännings 2014/30/EU - Elektromagnetisk Kompatibilitet 2009/125/EC - Energirelaterade produkter 2011/65/EU + 2015/863 - begränsning av användning av vissa farliga ämnen</p> <p>överrenstämmer också med följande relevanta standarder:</p> <p>EN 60335-1:2012+A11:2014+A13:2017+A1:2019+A2:2019+A14:2019+A15:2021; EN 60335-2-51:2003+A1:2008+A2:2012; EN IEC 61000-6-1:2019; EN IEC 61000-6-2:2019; EN IEC 61000-6-3:2021; EN IEC 61000-6-4:2019; EN 16297-1:2012; EN 16297-2:2012; EN IEC 63000:2018;</p> <p style="text-align: right;">WILO SE Group Quality Wilopark 1</p> <p style="text-align: right;">Person behörig att sammanställa denna tekniska fil är: D-44263 Dortmund</p>
GA	<p>Bidh sinn, an neach-déanamh, a' foillseachadh na aon uallach againn gu bheil na seòrsachan pumpa cuairteachaidh glandless seo den t-sreath, (Tha an àireamh sreathach air a chomharrachadh air clàr làrach an toraidh)</p> <p>anns an stàit ìbhridhig aca gèilleadh ris na stiùirdhean buntainneach a leanas agus ris an reachdas nàiseanta buntainneach:</p> <p> 2014/35/EU - Ìsealvoltais 2014/30/EU - Comhoiriúnacht Leictreamaighnéadach 2009/125/EC - Fuinneamh a bhaineann le tairgí 2011/65/EU + 2015/863 - Srian ar an úsáid a bhaint as substaintí guaiseacha acu</p> <p>gèilleadh cuideachd ris na h-inbhean iomchaidh a leanas:</p> <p>EN 60335-1:2012+A11:2014+A13:2017+A1:2019+A2:2019+A14:2019+A15:2021; EN 60335-2-51:2003+A1:2008+A2:2012; EN IEC 61000-6-1:2019; EN IEC 61000-6-2:2019; EN IEC 61000-6-3:2021; EN IEC 61000-6-4:2019; EN 16297-1:2012; EN 16297-2:2012; EN IEC 63000:2018;</p> <p style="text-align: right;">WILO SE Group Quality Wilopark 1</p> <p style="text-align: right;">Is e an neach le ughdarras am faidhle teicneach a chur ri chèile: D-44263 Dortmund</p>

BG Официален превод на Декларация	<p>Ние, като производител, декларираме на собствена отговорност, че помпите с мъкър ротор от серията, Серийните номера са обозначени на табелата на продукта</p> <p>Atmos PICO ...</p> <p>В доставения им вид са в съответствие приложимите за държавата директиви и законодателство</p> <p> 2014/35/EU - Ниско Напрежение 2014/30/EU - Електромагнитна съвместимост 2009/125/EC - Продукти, свързани с енергопотреблението 2011/65/EU + 2015/863 - относно ограничението за употребата на определени опасни вещества</p> <p>Също така отговарят на следните изискуеми норми:</p> <p>EN 60335-1:2012+A11:2014+A13:2017+A1:2019+A2:2019+A14:2019+A15:2021; EN 60335-2-51:2003+A1:2008+A2:2012; EN IEC 61000-6-1:2019; EN IEC 61000-6-2:2019; EN IEC 61000-6-3:2012; EN IEC 61000-6-4:2019; EN 16297-1:2012; EN 16297-2:2012; EN IEC 63000:2018;</p> <p>Лице, изпълнено от да състави техническия доклад е: D-44263 Dortmund</p> <p>WILO SE Group Quality Wilopark 1</p>
CS Oficiální překlad Prohlášení	<p>My, výrobce, prohlašujeme na základě naší výhradní odpovědnosti, že tyto bezpávkové oběhové čerpadlo řady, (Sériové číslo je uvedeno na výrobním štítku) ve svém dodaném stavu dodržovat následující relevantní směrnice a příslušnou národní legislativu:</p> <p>Atmos PICO ...</p> <p> 2014/35/EU - Nízké Napětí 2014/30/EU - Elektromagnetická Kompatibilita 2009/125/EC - Výrobků spojených se spotřebou energie 2011/65/EU + 2015/863 - Omezení používání některých nebezpečných látek</p> <p>dodržovat také následující relevantní normy:</p> <p>EN 60335-1:2012+A11:2014+A13:2017+A1:2019+A2:2019+A14:2019+A15:2021; EN 60335-2-51:2003+A1:2008+A2:2012; EN IEC 61000-6-1:2019; EN IEC 61000-6-2:2019; EN IEC 61000-6-3:2012; EN IEC 61000-6-4:2019; EN 16297-1:2012; EN 16297-2:2012; EN IEC 63000:2018;</p> <p>Osoba oprávněná sestavit technickou dokumentaci je: D-44263 Dortmund</p> <p>WILO SE Group Quality Wilopark 1</p>
HR Službeni prijevod Deklaracije	<p>Mi, proizvođač, izjavljujemo pod isključivom odgovornošću da ova mikrorotorna pumpa tipa iz serije, (Serijski broj je označen na tipskoj pločici proizvođa) u isporučenom stanju odgovara sljedećim relevantnim direktivama i relevantnom nacionalnom zakonodavstvu:</p> <p>Atmos PICO ...</p> <p> 2014/35/EU - Smjernica o niskom naponu 2014/30/EU - Elektromagnetna kompatibilnost - smjernica 2009/125/EC - Smjernica za proizvode relevantne u pogledu potrošnje energije 2011/65/EU + 2015/863 - ograničenju uporabe određenih opasnih tvari</p> <p>u skladu također i sa sljedećim relevantnim standardima:</p> <p>EN 60335-1:2012+A11:2014+A13:2017+A1:2019+A2:2019+A14:2019+A15:2021; EN 60335-2-51:2003+A1:2008+A2:2012; EN IEC 61000-6-1:2019; EN IEC 61000-6-2:2019; EN IEC 61000-6-3:2012; EN IEC 61000-6-4:2019; EN 16297-1:2012; EN 16297-2:2012; EN IEC 63000:2018;</p> <p>Osoba ovlaštena za sastavljanje tehničke dokumentacije: D-44263 Dortmund</p> <p>WILO SE Group Quality Wilopark 1</p>
HU A Nyilatkozat hivatalos fordítása	<p>Mi, a gyártó, saját felelősségünkre kijelentjük, hogy a sorozat nedvestengelyű keringető szivattyúi, (A sorozatszámot a termék adattábláján feltüntetjük) leszállított kivitelükben feleljenek meg a következő vonatkozó irányelveknek és a vonatkozó nemzeti irányelveknek</p> <p>Atmos PICO ...</p> <p> 2014/35/EU - Alacsony Feszültségű 2014/30/EU - Elektromágneses összeférhetőségre 2009/125/EC - Energiával kapcsolatos termékek 2011/65/EU + 2015/863 - egyes veszélyes való alkalmazásának korlátozásáról</p> <p>megfeleljen a következő vonatkozó előírásoknak is:</p> <p>EN 60335-1:2012+A11:2014+A13:2017+A1:2019+A2:2019+A14:2019+A15:2021; EN 60335-2-51:2003+A1:2008+A2:2012; EN IEC 61000-6-1:2019; EN IEC 61000-6-2:2019; EN IEC 61000-6-3:2012; EN IEC 61000-6-4:2019; EN 16297-1:2012; EN 16297-2:2012; EN IEC 63000:2018;</p> <p>A műszaki dokumentáció összeállítására jogosult személy: D-44263 Dortmund</p> <p>WILO SE Group Quality Wilopark 1</p>
PL Oficjalne tłumaczenie Deklaracji Zgodności	<p>Producent oświadcza na wyłączną odpowiedzialność, że typozeregi bez dławnicowych pomp obiegowych z serii (Numer seryjny znajdują się na tabliczce znamionowej produktu) w stanie dostarczonym są zgodne z następującymi dyrektywami i przepisami krajowymi mającymi zastosowanie:</p> <p>Atmos PICO ...</p> <p> 2014/35/EU - Niskich Napięć 2014/30/EU - Kompatybilności Elektromagnetycznej 2009/125/EC - Produktów związanych z energią 2011/65/EU + 2015/863 - sprawie ograniczenia stosowania niektórych niebezpiecznych substancji</p> <p>są również zgodne z następującymi specyfikacjami technicznymi mającymi zastosowanie:</p> <p>EN 60335-1:2012+A11:2014+A13:2017+A1:2019+A2:2019+A14:2019+A15:2021; EN 60335-2-51:2003+A1:2008+A2:2012; EN IEC 61000-6-1:2019; EN IEC 61000-6-2:2019; EN IEC 61000-6-3:2012; EN IEC 61000-6-4:2019; EN 16297-1:2012; EN 16297-2:2012; EN IEC 63000:2018;</p> <p>Osoba upoważniona do sporządzenia dokumentacji technicznej: D-44263 Dortmund</p> <p>WILO SE Group Quality Wilopark 1</p>

RO	<p>Noi, producătorul, declarăm sub responsabilitatea noastră exclusivă că aceste tipuri de pompe de recirculare cu rotor umed, din seria (Numărul serial este marcat pe plăcuța de identificare a produsului) în starea lor livrată, respectă următoarele directive relevante și legislația națională relevantă:</p> <p>Atmos PICO ...</p> <p> 2014/35/EU - Joasă Tensiune 2014/30/EU - Compatibilitate Electromagnetică 2009/125/EC - Produselor cu impact energetic 2011/65/EU + 2015/863 - privind restricțiile de utilizare a anumitor substanțe periculoase</p> <p>sunt conforme, de asemenea, cu următoarele standarde relevante</p> <p>EN 60335-1:2012+A11:2014+A13:2017+A1:2019+A2:2019+A14:2019+A15:2021; EN 60335-2-51:2003+A1:2008+A2:2012; EN IEC 61000-6-1:2019; EN IEC 61000-6-2:2019; EN IEC 61000-6-3:2012; EN IEC 61000-6-4:2019; EN 16297-1:2012; EN 16297-2:2012; EN IEC 63000:2018;</p> <p style="text-align: right;">WILO SE Group Quality Wilopark 1</p> <p style="text-align: right;">Persoana autorizată să compileze dosarul tehnic este: D-44263 Dortmund</p>
SK	<p>My, výrobca, na vlastnú zodpovednosť vyhlasujeme, že tieto bezcúpvákové obehové čerpadlá radu, (Sériové číslo je uvedené na štítku s výrobkom) v dodanom stave zodpovedajú nasledujúcim relevantným smerniciam a príslušným národným právnym predpisom:</p> <p>Atmos PICO ...</p> <p> 2014/35/EU - Nízkonapäťové zariadenia 2014/30/EU - Elektromagnetická Kompatibilitu 2009/125/EC - Energeticky významných výrobkov 2011/65/EU + 2015/863 - obmedzení používania určitých nebezpečných látok</p> <p>spĺňať aj nasledujúce relevantné normy:</p> <p>EN 60335-1:2012+A11:2014+A13:2017+A1:2019+A2:2019+A14:2019+A15:2021; EN 60335-2-51:2003+A1:2008+A2:2012; EN IEC 61000-6-1:2019; EN IEC 61000-6-2:2019; EN IEC 61000-6-3:2012; EN IEC 61000-6-4:2019; EN 16297-1:2012; EN 16297-2:2012; EN IEC 63000:2018;</p> <p style="text-align: right;">WILO SE Group Quality Wilopark 1</p> <p style="text-align: right;">Osoba oprávnená zostaviť technickú dokumentáciu je: D-44263 Dortmund</p>
SL	<p>Mi, kot proizvajalci, z polno odgovornostjo izjavljamo, da te vrste obtočnih črpalok brez železa serije, (Serijska številka je označena na napisni tablici izdelka) v stanju dostave ravnajo v skladu z naslednjimi ustreznimi direktivami in ustrezno nacionalno zakonodajo:</p> <p>Atmos PICO ...</p> <p> 2014/35/EU - Nizka Napetost 2014/30/EU - Elektromagnetno Zdržljivostjo 2009/125/EC - Izdelkov, povezanih z energijo 2011/65/EU + 2015/863 - o omejevanju uporabe nekaterih nevarnih snovi</p> <p>izpolnjujejo tudi naslednje ustrezne standarde:</p> <p>EN 60335-1:2012+A11:2014+A13:2017+A1:2019+A2:2019+A14:2019+A15:2021; EN 60335-2-51:2003+A1:2008+A2:2012; EN IEC 61000-6-1:2019; EN IEC 61000-6-2:2019; EN IEC 61000-6-3:2012; EN IEC 61000-6-4:2019; EN 16297-1:2012; EN 16297-2:2012; EN IEC 63000:2018;</p> <p style="text-align: right;">WILO SE Group Quality Wilopark 1</p> <p style="text-align: right;">Osoba, pooblaščenca za sestavo tehnične datoteke, je: D-44263 Dortmund</p>
TR	<p>Biz üretici olarak, sirkülasyon pompa tip serilerinin tamamen kendi sorumluluğumuz altında olduğunu beyan ederiz. (Seri numarasi ürünün üzerindedir.)</p> <p>Atmos PICO ...</p> <p>teslim edildigi şekliyle aşağıdaki ilgili hükümler ile uyumludur;</p> <p> 2014/35/EU - Alçak Gerilim Yönetmeliği 2014/30/EU - Elektromanyetik Uyumluluk Yönetmeliği 2009/125/EC - Eko Tasarım Yönetmeliği 2011/65/EU + 2015/863 - Belirli tehlikeli maddelerin bir kullanımını sınırladran</p> <p>İlgili uyumlaştırmış Avrupa standartları;</p> <p>EN 60335-1:2012+A11:2014+A13:2017+A1:2019+A2:2019+A14:2019+A15:2021; EN 60335-2-51:2003+A1:2008+A2:2012; EN IEC 61000-6-1:2019; EN IEC 61000-6-2:2019; EN IEC 61000-6-3:2012; EN IEC 61000-6-4:2019; EN 16297-1:2012; EN 16297-2:2012; EN IEC 63000:2018;</p> <p style="text-align: right;">WILO SE Group Quality Wilopark 1</p> <p style="text-align: right;">Teknik dosyayı düzenleyen yetkili kişi: D-44263 Dortmund</p>
MT	<p>Aħna, il-manifattur, niddikjaraw taht ir-responsabbiltà unika tagħna li dawn it-tipi ta' 'pompa ċirkolanti mingħajr glandola tas-serje, (In-numru tas-serje huwa mmarkat fuq il-pjan ta' tas-sitt tal-prodott) fl-istat mogħtija tagħhom jikkonformaw mad-direttivi rilevanti li għejjin u mal-legislazzjoni nazzjonali rilevanti:</p> <p>Atmos PICO ...</p> <p> 2014/35/EU - Vultaġġ Baxx 2014/30/EU - Kompatibbiltà Elettromanjetika 2009/125/EC - Prodotti relatati mal-enerġija 2011/65/EU + 2015/863 - dwar ir-restrizzjoni tal-użu ta' ċerti sustanzi perikolużi</p> <p>jikkonformaw ukoll mal-istandards rilevanti li għejjin:</p> <p>EN 60335-1:2012+A11:2014+A13:2017+A1:2019+A2:2019+A14:2019+A15:2021; EN 60335-2-51:2003+A1:2008+A2:2012; EN IEC 61000-6-1:2019; EN IEC 61000-6-2:2019; EN IEC 61000-6-3:2012; EN IEC 61000-6-4:2019; EN 16297-1:2012; EN 16297-2:2012; EN IEC 63000:2018;</p> <p style="text-align: right;">WILO SE Group Quality Wilopark 1</p> <p style="text-align: right;">Persoana awtorizzata biex tiġbor il-fajl tekniku hija: D-44263 Dortmund</p>









wilo



Local contact at
www.wilo.com/contact

WILO SE
Wilopark 1
D-44263 Dortmund
Germany
T +49(0)231 4102-0
F +49(0)231 4102-7363
wilo@wilo.com
www.wilo.com

Pioneering for You